

Power

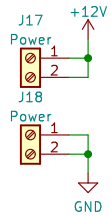

MCU

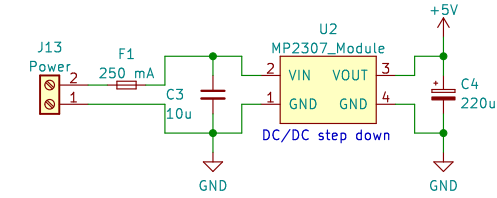
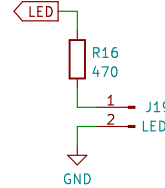
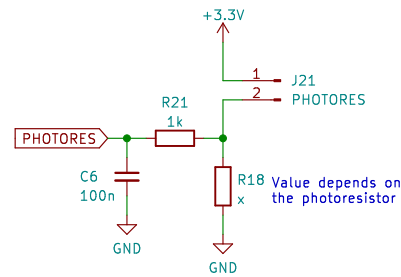
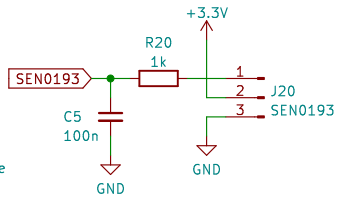
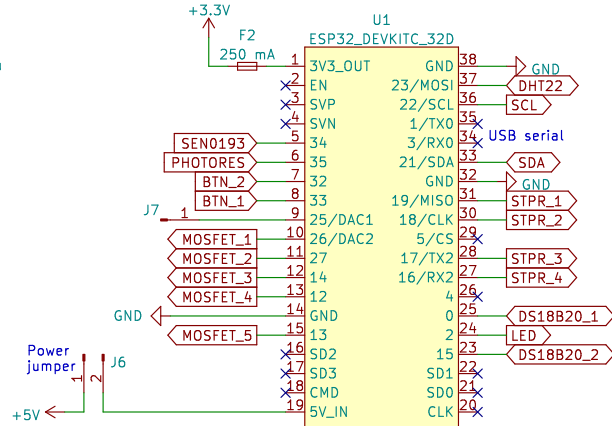

Inputs – buttons

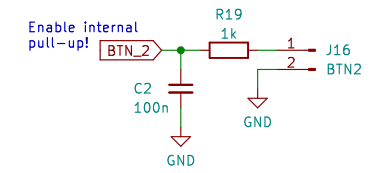
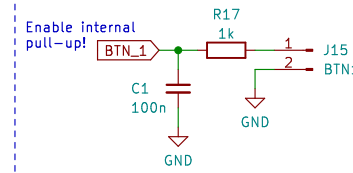

Outputs – MOSFET PWM

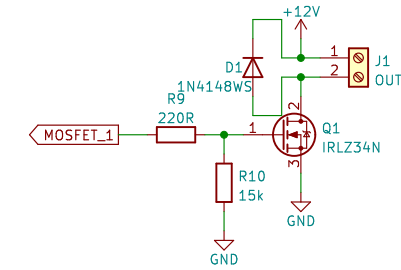
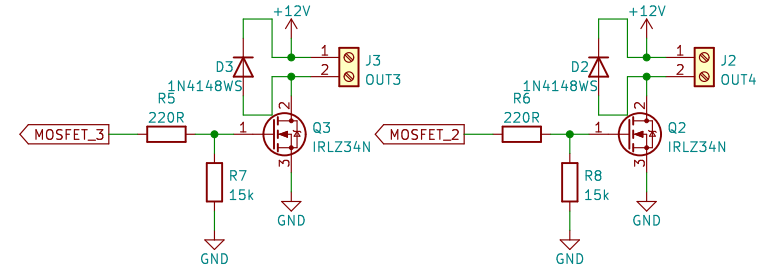
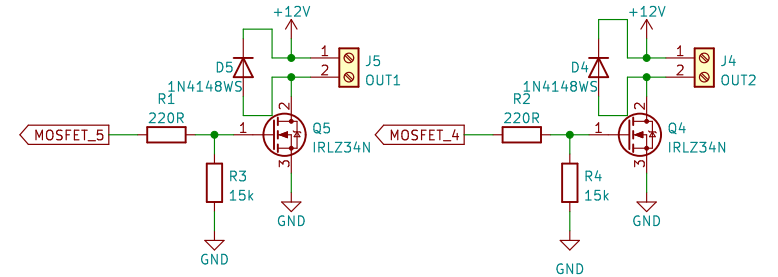

I2C + 3V3

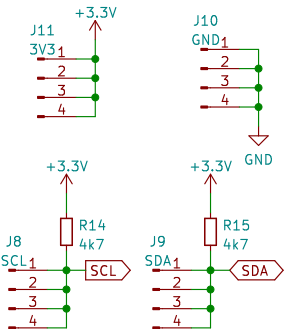

Temperature sensors

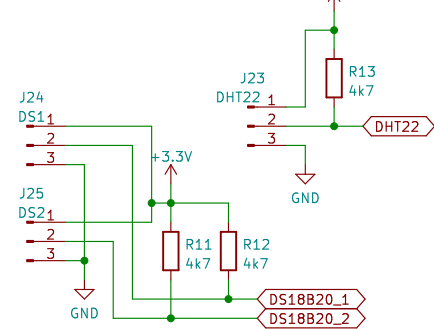

Stepper signals + 5V

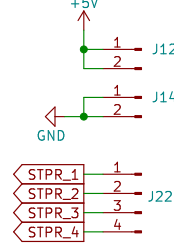

- H1 MountingHole
- H2 MountingHole
- H3 MountingHole
- H4 MountingHole