

CAN OBD2

USB
798-ZX62D-B-5PA830

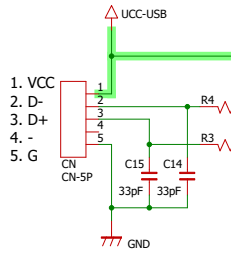

FTDI
895-FT231XQ-R

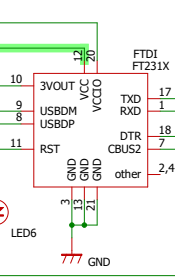

1.8 - 3.6V
4A 12mA@+4db
BLE \$14
975-RFD77101

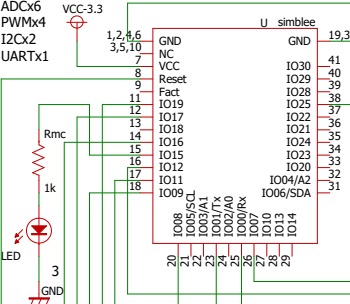

EEPROM 0x50
1.6 - 5.5V \$0.3
64kbit

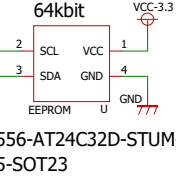

- 0:UART Rx
 - 1:UART Tx
 - 7:SW
 - 9:SPI MOST
 - 11:RGB LED
 - 12:SCL
 - 15:LED
 - 16:SPI MISO
 - 17:SPI CLK
 - 19:SPI CS
 - 23:EX
 - 25:SDA
- Serial.begin(9600,RXpin,TXpin);"

- SS 6 >> 18
 - MOSI 5 >> 11 >> 30 >> 9
 - MISO 3 >> 16
 - CLK 4 >> 30 >> 17
- CONTROL
- 23: EX
 - 19: SS
 - 9: MOSI
 - 16: MISO
 - 17: CLK

CAN
MCP2515+MCP2551

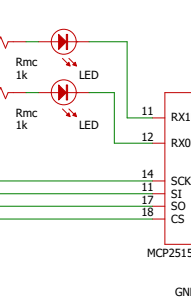

5V Reg

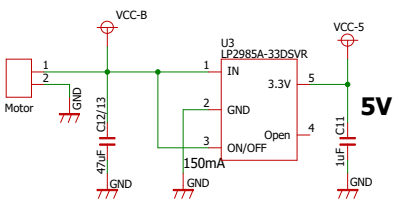

RGB LED

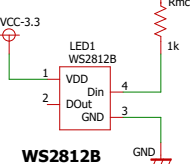

3.3V Reg

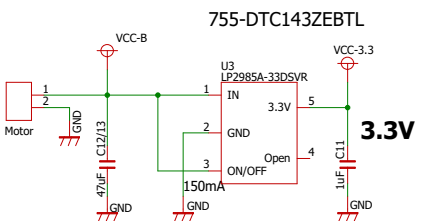

Neo Pixel mini 3535 (adafruit)
3.5-5.3V (ID:2686)

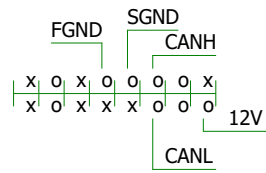

TITLE		DRAWING_No	
CAN OBD2			
SHEET	DATE	DESIGN	
1 / 1	6/20/17	mmizuno	